

輕便安裝型石背螺絲
S.S. Light Duty Stone Back Anchor [SW-BA M6]

概念與構思：(適合用於室內安裝)

- 1 用更少的天然石材，減輕重量及節省成本，營造一樣的外貌效果，但發揮出更強更穩定的結構數據。
- 2 配合濕裝石材工程，加固大部分石材之結構力。
- 3 防火、防震。



Concepts and ideas : (Suitable for indoor installation)

- 1) Consume lesser natural stone, reduce weight and save the cost, in order to demonstrate the same effect. The pullout force have more strength and stable.
- 2) Strengthen the fixing structure of the stone wet-installation.
- 3) Anti-fire and anti-vibration.

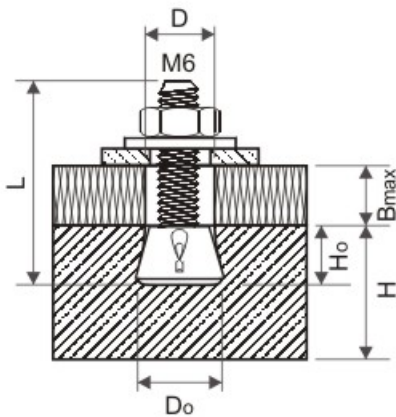

Item	Model	項目	型號	M6
H (mm)	Manufacturer's recommended stone panel thickness	H (mm)	製造商建議之石材厚度	≥15
D (mm)	Drill hole diameter	D (Mm)	鑽孔直徑	12
Do (mm)	Hole base diameter	Do (Mm)	基本孔直徑	13
Ho (mm)	Manufacturer's recommended drill hole depth	Ho (mm)	製造商建議鑽孔深度	7.5
Bmax(mm)	Max. Thickness of installation material	Bmax(mm)	最大安裝板材厚度	15
L (mm)	Anchor total length(standard)	L (Mm)	螺絲總長度(標準)	30
Advance Order		需預訂		
L (mm)	Anchor total length(shortest)	L (mm)	螺絲總長度(最短)	20
L (mm)	Anchor total length(longest)	L (Mm)	螺絲總長度(最長)	80

安裝程序 (For Reference)

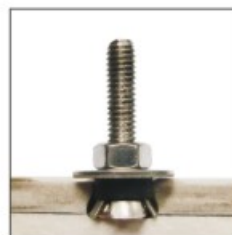
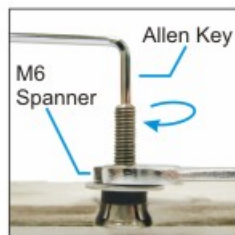
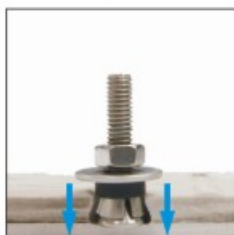
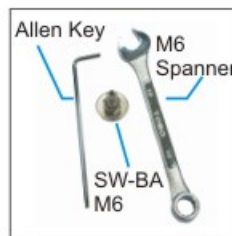
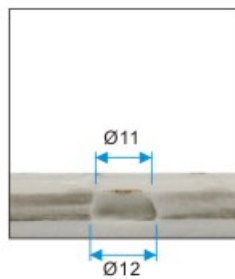
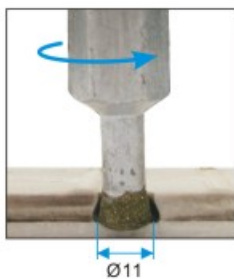
Installation Procedure

1. Drill hole by the drilling machine.
2. Hole is enlarged to $\phi 12$ mm, by the drilling machine
3. Prepare Stone Back Anchor SW-BA M6, Allen Key and M6 Spanner for installation.
4. Clean the drill hole and insert Stone Back Anchor SW-BA M6.
5. Use M6 Spanner and Allen Key to tighten the Stone Back Anchor for expansion.
6. Installation Complete.

- 1 用鑽機把石鑽孔。
- 2 用鑽機把鑽孔撥大至 $\phi 12$ mm。
- 3 預備石背螺絲 SW-BA M6，六角匙和M6士巴拿作安裝之用。
- 4 清潔鑽孔，插入石背螺絲 SW-BA M6 於孔內。
- 5 使用M6士巴拿和六角匙，把石背螺絲收緊。
- 6 安裝完成。

如需更多資料或有任何疑問，請與我們聯絡。

For more information, please contact us.

Tel : (852) 2873 2804 , E-mail : sung@sunwayltd.com.hk

Fax : (852) 2814 0776 , Website : <http://www.sunwaymetal.com/>

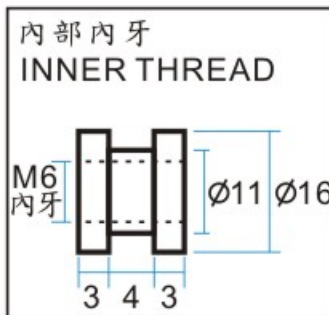

材料
Material: S.S. 304 / S.S. 316

尺寸：
如圖所示或按客戶要求
Size: As shown on dwg
or tailor made base on
request

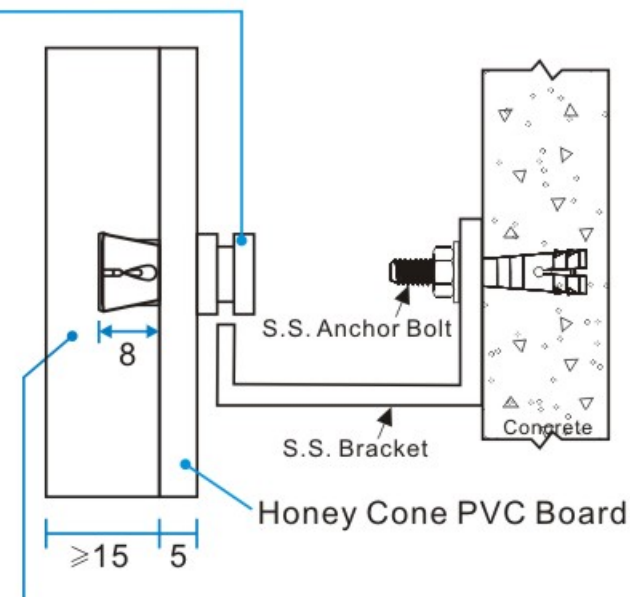

材料：薄石材
Material: Natural Stone

用途：室內大堂或室外低層之乾扣設計
Application: Indoor or lower level outdoor
dry fixing installation.

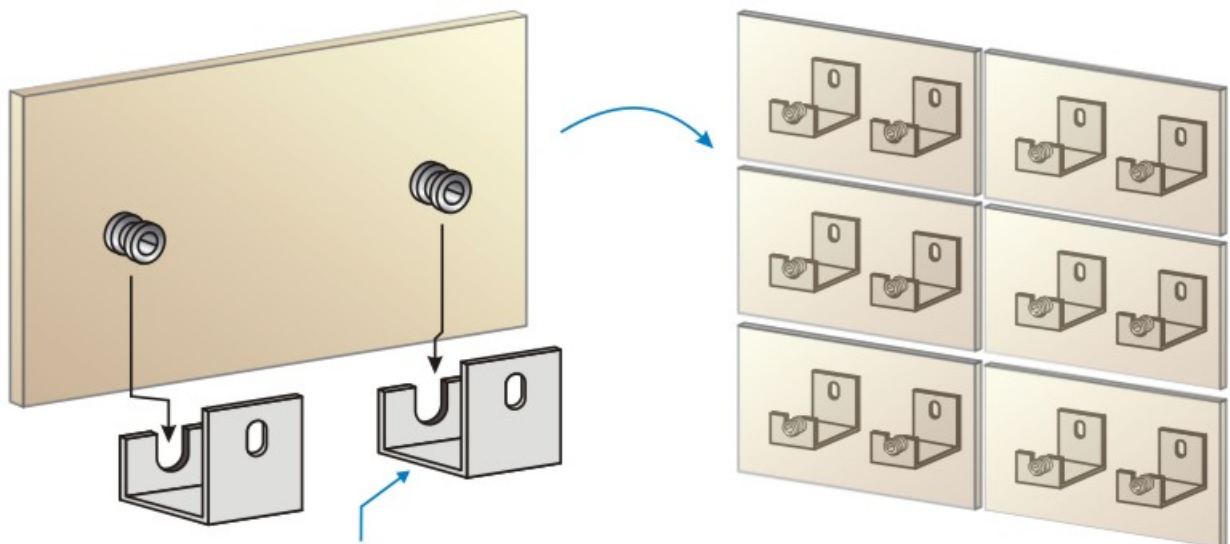

可配合防震U型扣件
Use with U sharp Anti-slip Bracket.

如需更多資料或有任何疑問，請與我們聯絡。
For more information, please contact us.
Tel: (852) 2873 2804 , E-mail: sung@sunwayltd.com.hk
Fax: (852) 2814 0776 , Website: <http://www.sunwaymetal.com/>

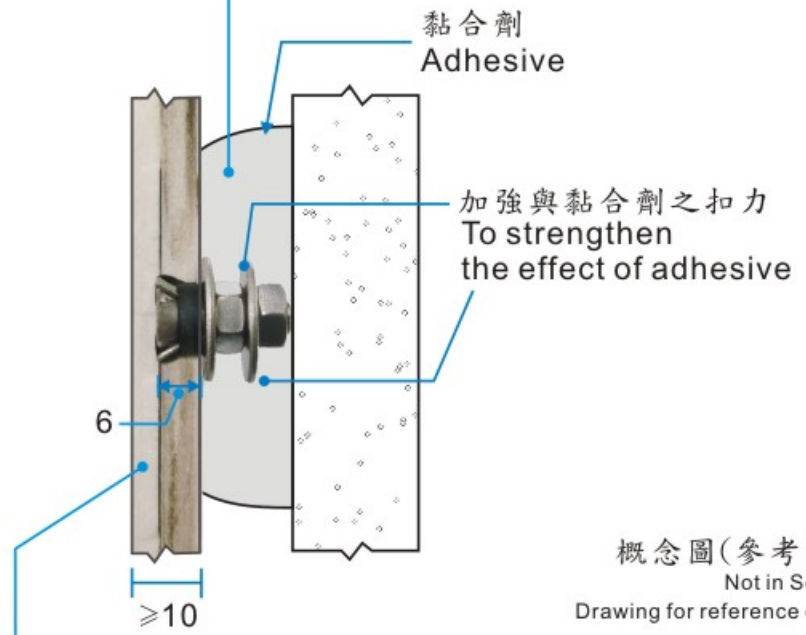
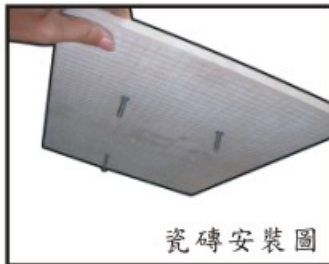

概念圖(參考圖)
Not in Scale
Drawing for reference only

材料：薄石材/瓷磚

Material: Natural Stone / Ceramic Tile

用途：配合黏合劑混安裝之用

Application: Use with adhesive together

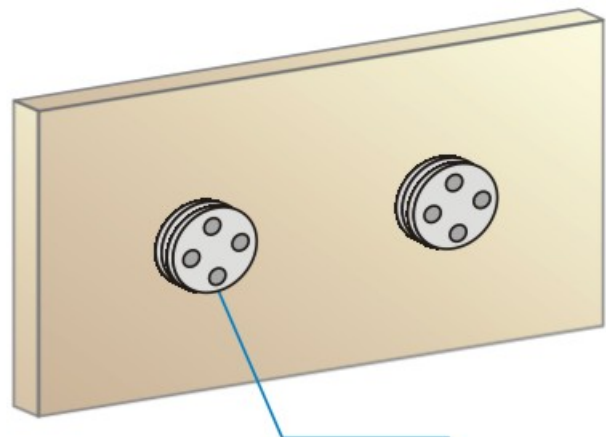

加強與黏合劑之扣力
To strengthen the effect of adhesive

如需更多資料或有任何疑問，請與我們聯絡。

For more information, please contact us.

Tel : (852) 2873 2804 , E-mail : sung@sunwayltd.com.hk

Fax : (852) 2814 0776 , Website : <http://www.sunwaymetal.com/>

概念圖(參考圖)

Not in Scale

Drawing for reference only

November 2011

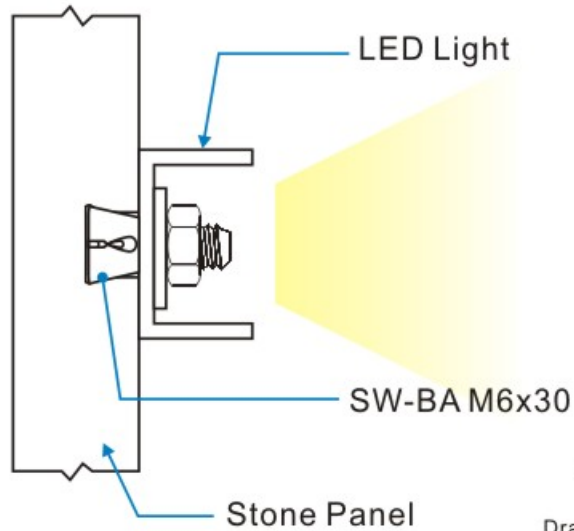

概念圖(參考圖)
Not in Scale
Drawing for reference only

材料：LED顯示屏／燈飾設備

用途：安裝燈飾設備於石材上，營造透光效果。
適用於各大商場，辦公大樓外牆作宣傳用途或室內指示牌等。



材料：大型裝飾掛件，
玻璃纖維配件等

用途：安裝或外掛大型裝飾
結構，園林假山石等玻璃纖
維組件配合主題造型佈置商
場外牆或室內。

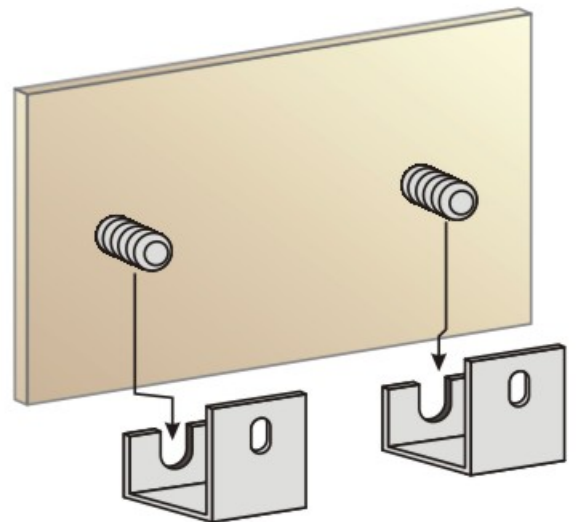
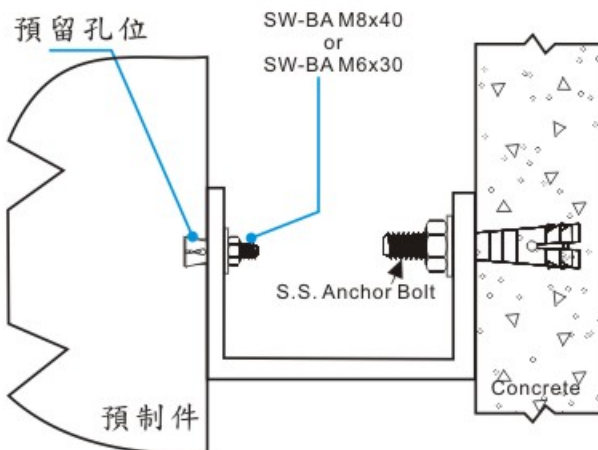

如需更多資料或有任何疑問，請與我們聯絡。
For more information, please contact us.
Tel : (852) 2873 2804 , E-mail : sung@sunwayltd.com.hk
Fax : (852) 2814 0776 , Website : <http://www.sunwaymetal.com/>